

Article number: 0102236

Description: Retaining ring J580 DIN472
Spring steel

Measures

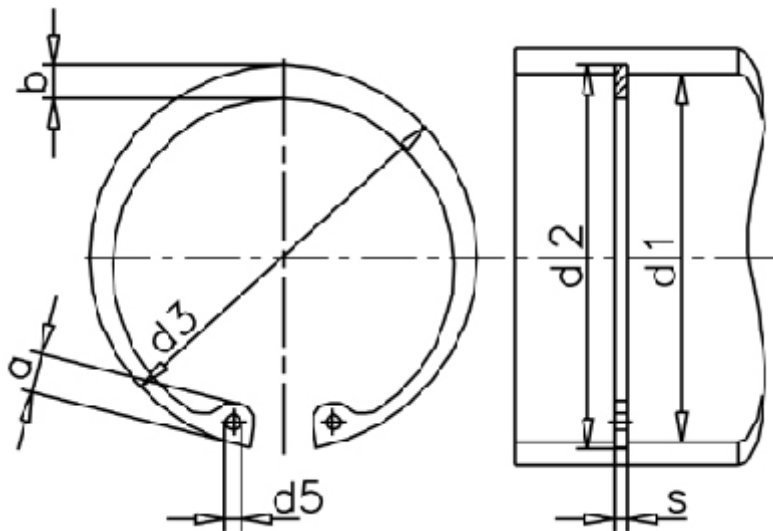

a max	=	FN kN	= 2151.00	t	= 7.00
AN mm ²	= 12909.0	FRg kN	= 138.0	tol	= +1,00
b	= 26.0	FR kN	= 1627.0	tol	= +3,00-1,50
d1	= 580	g	= 7.0	tol	= -0.15
d2	= 594.0	K kN-mm	= 3728.0	Tong	= ZGJ-5
d3	= 605.00	m min	= 8.20	Weight kg/1000	= 2625.00
d5 min	= 6.0	Nominal drive	= 21.0		
Description = J 580		s	= 8.00		